

A high-angle, perspective view of a modern KONE escalator. The escalator is silver with black handrails and a glass side panel. The steps are silver with a textured surface. A yellow safety strip runs along the edge of the landing. A green arrow sign is visible on the handrail. The background is a grey tiled floor.

SMOOTH PEOPLE FLOW[®] FOR COMMERCIAL ENVIRONMENTS

KONE TravelMaster™ 110



YOUR TRUSTED ESCALATOR PARTNER

With over 100 years of experience and a strong track record in safety, KONE is your trusted partner, dedicated to ensuring smooth and safe People Flow™ in today's commercial environments. KONE escalators and autowalks use our proven, reliable technology designed to meet the wide-ranging needs of commercial buildings worldwide.

The KONE TravelMaster™ 110 escalator is designed for commercial environments, where safety, design and eco-efficiency are key requirements.

3 REASONS TO CHOOSE KONE TRAVELMASTER 110

1 ECO-EFFICIENT ESCALATORS THAT REDUCES OPERATIONAL COSTS

- **Smart operational modes and an all new inverter** optimize energy consumption under different load conditions
- **Long lasting LED lighting** is up to 80% more efficient than fluorescent lighting and lasts up to 10 times longer



The KONE TravelMaster 110

- Vertical rise: Up to 13 meters
- Horizontal steps: 2 or 3
- Inclination: 30°, 35°
- Step width: 600 mm, 800 mm, 1000 mm
- Radius: 1.0/1.0, 1.5/1.0
- Balustrade height: 900 mm, 1000 mm, 1100 mm
- Speed: 0.5 m/s, 0.4 m/s with inverter
- Step chain: Inside roller chains
- Operational environment: Indoor, semi-outdoor, full outdoor
- Duty cycle: 14 hours/day

2 PEACE OF MIND WITH THE LATEST SAFETY TECHNOLOGY

- **New traffic signalization solutions**
- **Audible alarms** provide clear guidance on escalator travel direction

3 HIGH QUALITY VISUAL DESIGN FOR THE BEST POSSIBLE USER EXPERIENCE

- **Innovative and attractive lighting solutions** that also improve passenger guidance and safety
- **A wide range of design options** to create stunning visual effects and perfectly match your building's architecture
- **High quality component finishes** and a harmonized look and feel throughout the KONE product portfolio

ECO-EFFICIENT ESCALATOR

At KONE we have always been renowned for our revolutionary eco-efficient technology. Installing an eco-efficient KONE escalator solution can also help achieve green building accreditations such as LEED or BREEAM certification.

1 ALL-NEW ENERGY EFFICIENT INVERTER

The renewed inverter ensures smooth speed regulation during standby operation and minimizes energy consumption at full speed.

2 ECO-EFFICIENT OPERATIONAL MODES

Eco-efficient operational modes save energy by slowing down or stopping the escalator completely when traffic is low. For example, when an escalator is empty, energy consumption is further reduced with KONE's smart star-delta operational mode, which regulates the current needed for different types of load situations.

3 LONG-LASTING LED LIGHTING

LED lighting is up to 80% more efficient than fluorescent lighting and lasts up to 10 times longer.



U.S. based business magazine Forbes has ranked KONE the 56th most innovative company in the world. KONE is the only elevator and escalator company featured on Forbes' list this year.





PEACE OF MIND

WITH THE LATEST SAFETY TECHNOLOGY

When you choose KONE, you choose peace of mind. Safety is the starting point for every KONE solution. All our escalators are designed to meet and exceed all applicable safety standards, codes, and regulations to ensure the highest levels of safety every step of the way – from planning and installation to maintenance and modernization. In addition, we offer new and innovative features to ensure that KONE escalators are the benchmark whenever safety is concerned.

The KONE TravelMaster™ 110 has been designed to both maximize safety for passengers and make it easy to inspect the condition of the equipment, ensuring that it operates reliably and safely at all times.

Standards-compliant manufacturing

All KONE manufacturing units are ISO 14001 certified and meet all relevant escalator industry standards and requirements. KONE escalators comply with international codes such as EN115, as well as local codes that incorporate additional requirements for escalator safety.

COMPREHENSIVE RANGE OF SAFETY OPTIONS

1 ALARM FOR TRAVEL DIRECTION

An alarm sounds if passengers enter an escalator in the wrong direction

2 VISUAL GUIDANCE

Traffic signalization, skirt lighting, yellow comb segment, and step demarcations provide extra visual guidance for passengers.

3 FALL-PREVENTION FEATURES

A fall-protection barrier and extended balustrades provide additional passenger protection.

For a complete list of standard and optional safety features please contact your local KONE sales representative.

HIGH QUALITY VISUAL DESIGN

FOR THE BEST POSSIBLE USER EXPERIENCE

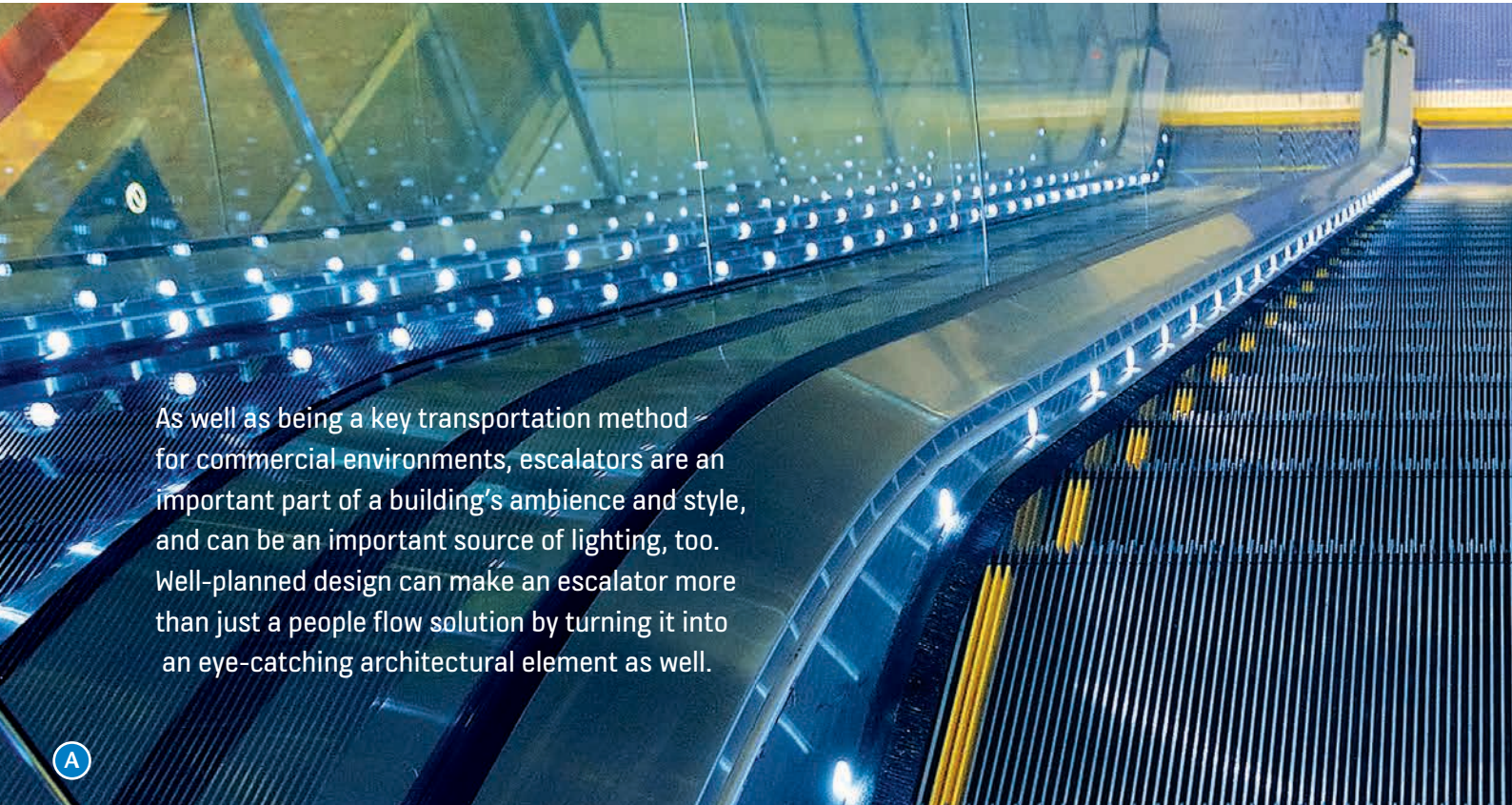

As well as being a key transportation method for commercial environments, escalators are an important part of a building's ambience and style, and can be an important source of lighting, too. Well-planned design can make an escalator more than just a people flow solution by turning it into an eye-catching architectural element as well.

1 INNOVATIVE AND ATTRACTIVE LIGHTING SOLUTIONS

KONE's new cladding, lighting solutions for signs, and traffic lights provide the final touch to your escalator's visual design. Our traffic-light options – cube, road sign, and traffic pole – provide a simple, stylish approach to safety and passenger guidance.

2 A WIDE RANGE OF DESIGN OPTIONS

KONE's design offering consists of a wide range of innovative materials and features. The combination of unique textured and patterned cladding materials with novel lighting solutions creates a stunning visual effect.

3 ATTENTION TO DETAIL AND EXCELLENT FINISHING QUALITY

All of our escalator components are designed with great attention to detail. KONE escalators are equipped with attractive front plates, guards, and access covers – all with high quality finishing. The design of KONE products is harmonized throughout our portfolio for a consistent look and feel in your building.

4 TAILOR-MADE POSSIBILITIES

KONE's renowned engineering and design capabilities are always available to help you realize your architectural vision with customized specifications for your premises.

New attractive lighting and guidance solutions that improve the safety of your escalator: ▶

- A. LED skirt spot lighting
- B. Traffic light cube
- C. Traffic light road sign
- D. LED skirt lighting



THE RIGHT ESCALATOR FOR YOUR OPERATIONAL NEEDS

KONE TRAVELMASTER™ 110

The KONE TravelMaster 110 solution is a reliable, efficient escalator package designed for retail environments. It complies with all relevant international and local safety codes, and can be enhanced with the latest KONE signalization and LED lighting options for additional convenience, passenger guidance, and visual appeal. It includes a worm gear combined with the smart star-delta operational mode which automatically regulates the current needed depending on the actual step load.

KONE TRAVELMASTER™ 110 ECO

The KONE TravelMaster 110 Eco solution is a high-quality, eco-efficient escalator package designed for high-end retail and hotel environments, as well as airports, including KONE's new traffic signalization and LED lighting options for improving passenger guidance and creating a high-quality visual design.



KONE TRAVELMASTER 110

Worm gear

TRADITIONAL FRICTION WHEEL HANDRAIL DRIVE

ENERGY EFFICIENCY ENHANCING OPTIONS:

- New energy efficient inverter
- Multiple operational modes
- Regenerative drive
- LED lighting options
- Traffic lighting solutions (pole, cube, road sign)
- Guidance lighting solutions (comb lighting, step demarcation lighting)

SAFETY ENHANCING OPTIONS:

- Alarm for travel direction
- Fall protection barrier

DESIGN ENHANCING OPTIONS

- LED continuous lighting or RGB solution for skirt, handrail, side cladding and soffit
- LED spot lighting for skirt and soffit (basic and premium)
- New premium stainless steel access cover
- New KONE designed claddings (etched, honeycomb, colored glass or laminated)

SUPPORTING YOU EVERY STEP OF THE WAY

Choose a partner with over a century of experience in delivering pioneering escalator solutions. Get expert advice from professionals and enjoy the peace of mind that comes with comprehensive support. KONE is with you every step of the way – from planning and design, through installation and maintenance, to modernization – for the entire life cycle of your building.

1 EXPERT DESIGN AND PLANNING SERVICES

- Expert planning advice helps you specify the optimal solution for your building.
- Easy-to-use online design tools save you time and effort during the design process by allowing you to create CAD drawings and 3D BIM models.
- Energy consumption calculations available for every individual escalator solution.

2 SAFE AND EFFICIENT INSTALLATION

- Highly efficient installation methods result in considerable cost savings for our customers and minimize disruption to other construction work.
- Strict quality criteria for each phase of installation ensure that it's right the first time, every time.
- Continuous training, site audits, safety passports, and proven methods ensure maximum site safety.
- Eco-efficient installation processes maximize waste recycling.

3 QUALITY ASSURANCE AT HANDOVER AND PROFESSIONAL MAINTENANCE

- KONE's own reliability laboratory tests and approves every component used in our escalator solutions.
- Our global spares center stocks over 150,000 parts and offers 24-hour delivery for the most commonly requested parts.
- Preventive KONE Care® maintenance solutions – including a comprehensive new online service-reporting system – make it easier to monitor and budget for escalator maintenance.

WORLD-CLASS DESIGN TOOLS

KONE Escalator Toolbox – including BIM models

- With the **KONE Escalator Toolbox** you can create a detailed equipment specification online and customized CAD drawings for preliminary planning.

- **KONE Building Information Modeling (BIM)** models make it easier and quicker for architects to prepare digital escalator designs. Included in the Escalator Toolbox, these models are compatible with most common project documentation systems and include the latest KONE escalator specifications. Once your design is ready, you can send the specifications directly to a KONE sales representative for tendering and/or ordering.

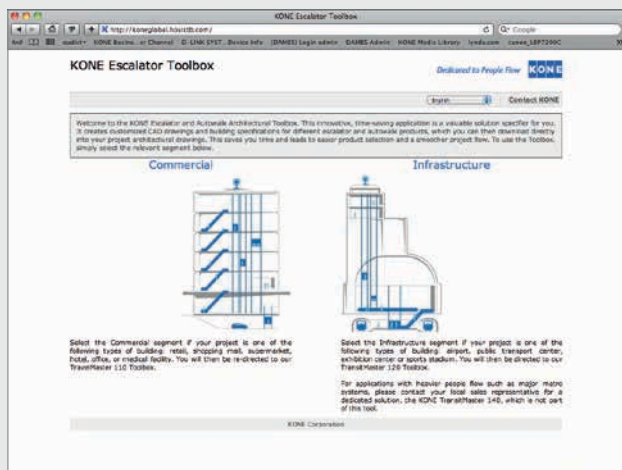

The KONE Escalator Toolbox is available online at <http://koneglobal.hostctb.com/>

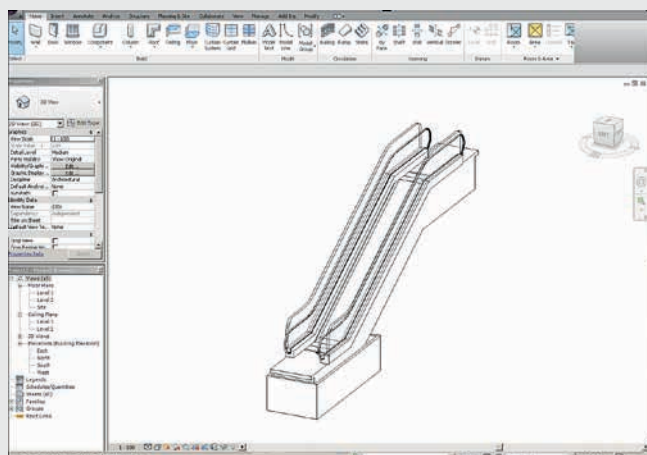

VISUAL DESIGN AND CUSTOMIZAT

KONE escalators combine industry-leading eco-efficiency and the latest safety technology with a wide range of high quality design options – all supported by our unrivalled engineering and people flow expertise. Our sales teams provide expert advice that will help you choose exactly the right solution for your building. And with our latest range of design options, you can create an escalator that is both an essential means of transportation and an eye-catching architectural element.



CLADDINGS

Brushed stainless steel



ST4*
Silver

* For more brushed stainless steel options please contact your sales representative

** Available with honey comb structure

Colored laminate**



LH001
Dotted White

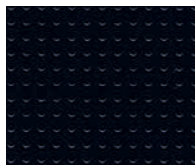

LH002
Dotted Black



LH003
Navy Blue

Metallic and pearlescent laminate**



LH004
Pearl Steel

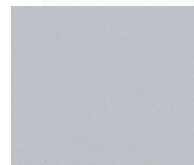

LH005
Pearl Silver

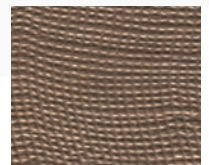

LH006
Bronze Mesh

Colored glass



G104
Bronze

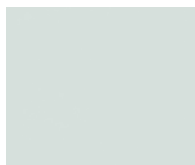

G105
Bright White

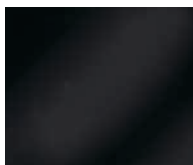

G107
Black Pearl

Etched stainless steel**



ES3
Silver High-Rise



ST41S
Silver Bamboo

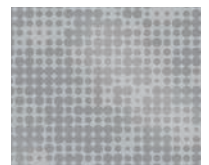

ST42S
Silver Cloud

ION CAPABILITIES

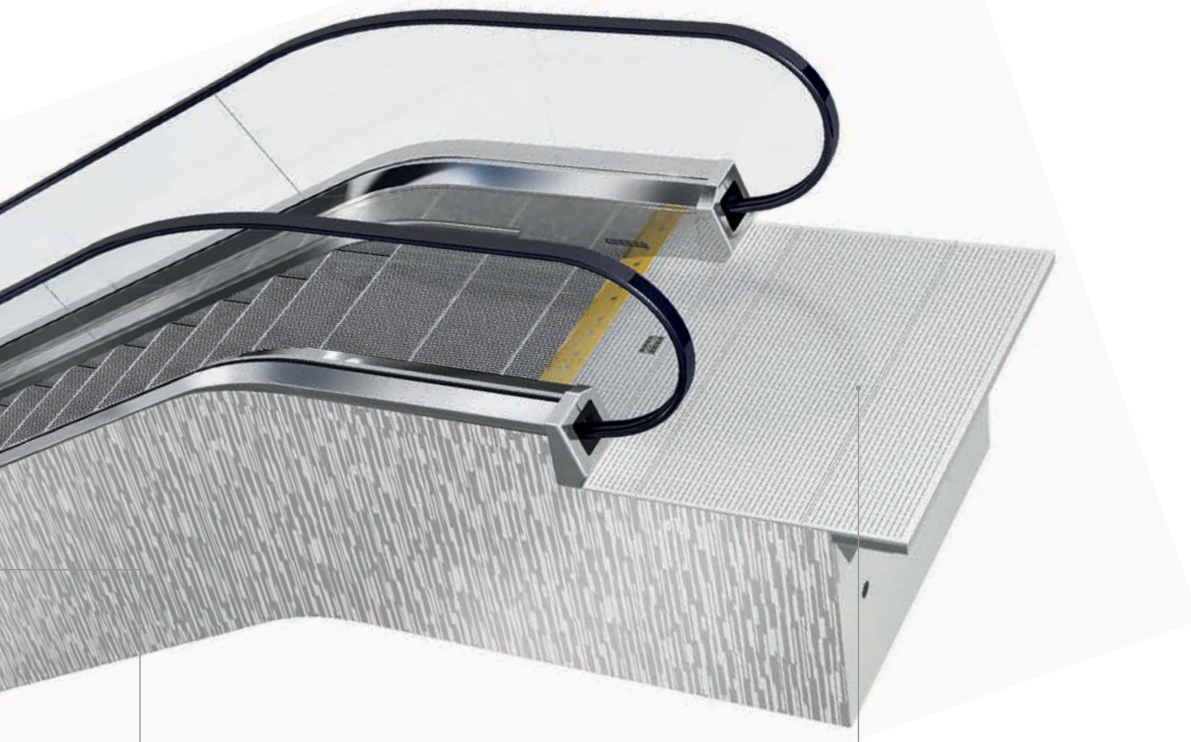

TRAFFIC LIGHT SIGNALIZATIONS



Traffic light cube



Traffic light road sign

ACCESS COVERS

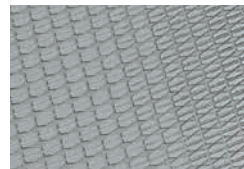

Stainless steel surface with punched diamond pattern (available in 304# and 443#)

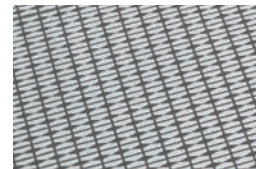

Black painted Stainless steel surface with punched diamond pattern (available in 304# and 443#). Floor numbering is available.

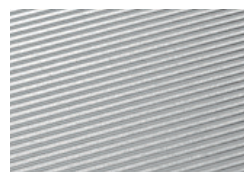

Natural ribbed aluminum

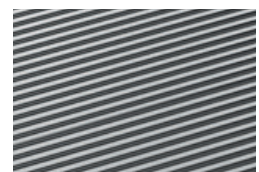

Ribbed aluminum with black grooves



Stainless steel surface
New KONE Design access cover



KONE provides innovative and eco-efficient solutions for elevators, escalators, automatic building doors and the systems that integrate them with today's intelligent buildings.

We support our customers every step of the way; from design, manufacturing and installation to maintenance and modernization. KONE is a global leader in helping our customers manage the smooth flow of people and goods throughout their buildings.

Our commitment to customers is present in all KONE solutions. This makes us a reliable partner throughout the life cycle of the building. We challenge the conventional wisdom of the industry. We are fast, flexible, and we have a well-deserved reputation as a technology leader, with such innovations as KONE MonoSpace[®], KONE NanoSpace[™] and KONE UltraRope[®].

KONE employs close to 50,000 dedicated experts to serve you globally and locally.

KONE Corporation
www.kone.com

KONE OFFICES IN SOUTH EAST ASIA

Indonesia - PT. KONE Indo Elevator

Jakarta (main office)	+61 21 6570 3990
Bali	+62 361 895 7806
Bandung	+62 22 8606 0804
Makassar	+62 411 466 2780
Surabaya	+62 31 855 6383
Yogyakarta	+62 274 284 0089

www.kone.co.id

Malaysia - KONE Elevator (M) Sdn Bhd

Kuala Lumpur (main office)	+603 7494 7500
Johor Bahru	+607 559 0885
Penang	+604 656 3222
Sabah	+601 1278 0560

www.kone.my

Philippines - KPI Elevators, Inc.

Makati City (main office)	+632 811 2929
Cebu	+63 32 233 5790

www.kone.ph

Singapore - KONE Pte Ltd

Singapore	+65 6424 6246
-----------	---------------

www.kone.sg

Thailand - KONE Public Company Limited

Bangkok	+66 2784 6500
---------	---------------

www.kone.co.th

Vietnam - KONE Vietnam LLC

Ho Chi Minh (main office)	+84 28 3997 5373
Hanoi	+84 24 3974 9445

www.kone.vn

DISTRIBUTORS IN SOUTH EAST ASIA

Brunei

Yusoki Sdn Bhd	+673 2790037
----------------	--------------

Cambodia

Comin Khmere	+855 23 885 640
--------------	-----------------

Laos

Comin Asia	+856 30 777 4777
------------	------------------

Myanmar

Octagon Automobile & Machinery Services Co., Ltd	+95 9 8631438
--	---------------

Sarawak(Malaysia)

Elebest Engineering Sdn Bhd	+60 82 365836
-----------------------------	---------------